

PLAN VIEW
APROX WEIGHT - 1,450 LBS

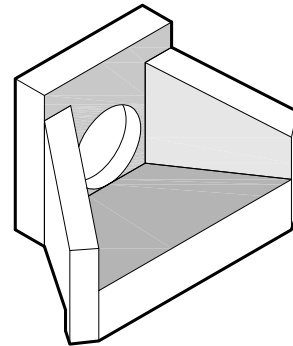

**NC HEADWALL
ISOMETRIC VIEW**

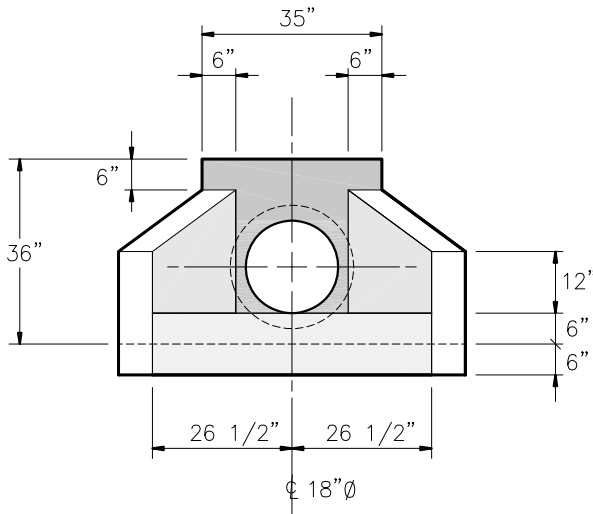

ELEVATION

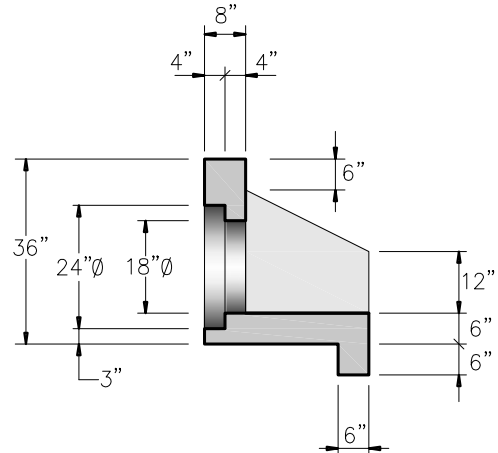

SECTION A-A

GENERAL NOTES:

- 4500 PSI CONCRETE AT 28 DAYS
- ASTM A615, GRADE 60 REINFORCING
- HS 20 LOADING

REINFORCEMENT:

#4 BARS @ 9" O.C. E.W.
OR EQUIV. W.W.M.



9235 Main Street #1
P.O. Box 507
Needville, Texas, 77461
1-888-331-5871

"Providing Concrete Environmental Solutions"

18" NC HEADWALL

NC-006-064

Scale: 1/4"=1'-0"
* All Dimensions subject to allowable specification tolerances.

Date: 03/05/19

Rev Date:

Approved By: _____ Date: _____